

**VYTEC®**

**VINYL SIDING &  
ACCESSORIES**



*performance* **DRIVEN**

**2023 PRODUCT CATALOG**

**HEARTWOOD™ SHINGLES**

PAGE 6



**PRESTIGE®**

PAGE 7



**BOARD & BATTEN**

PAGE 8



**PROSIDE®**

PAGE 9



**NANTUCKET® 2.0**

PAGE 10



**BEADED PORCH PANEL**

PAGE 11



**SOFFIT**

PAGES 11-12



**ACCESSORIES**

PAGES 13-16



# SIDING AND SOFFIT MATRIX

## TABLE OF CONTENTS SIDING PRODUCTS

		WHITE	COLORS					PREMIUM COLORS					EXPRESSIONS® COLORS					DARK										
			BUTTERCREAM	CLASSIC GRAY	MAPLEWOOD	NATURAL SAND	SAND DRIFT	SIERRA BROWN	CANYON RIDGE	CAROLINA BLUE	CASTLE STONE	GRASSLANDS	LAKESHORE BLUE	RUSTIC CLAY	SPRING MEADOW	TUNDRA MOSS	TWILIGHT GRAY	FOREST	HARBOUR	MARINE BLUE	MOCHA BROWN	REDWOOD	RUSTIC OAK	SHORELINE	SMOKESTONE	SMOKY QUARTZ	SMOKY STEEL	BLACK
<b>PAGE 6</b>	<b>HEARTWOOD™ SHINGLES</b>																											
	Single 7" Perfection	●	●	●	●	●	●	●	●	●	●	●	●	●	●	●	●	●	●	●	●	●	●	●	●	●	●	●
<b>PAGES 7</b>	<b>PRESTIGE®</b>																											
	Double 4-1/2" Traditional	●	●	●	●	●	●	●	●	●	●	●	●	●	●	●	●	●	●	●	●	●	●	●	●	●	●	●
	Double 4-1/2" Dutch Lap	●	●	●	●	●	●	●	●	●	●	●	●	●	●	●	●	●	●	●	●	●	●	●	●	●	●	●
	Double 5" Dutch Lap	●	●	●	●	●	●	●	●	●	●	●	●	●	●	●	●	●	●	●	●	●	●	●	●	●	●	●
<b>PAGE 8</b>	<b>BOARD &amp; BATTEN</b>																											
	Single 7" Vertical	●	●	●	●	●	●	●	●	●	●	●	●	●	●	●	●	●	●	●	●	●	●	●	●	●	●	●
<b>PAGE 9</b>	<b>PROSIDE®</b>																											
	Double 4-1/2" Traditional	●	●	●	●	●	●	●	●	●	●	●	●	●	●	●	●											
	Double 4-1/2" Dutch Lap	●	●	●	●	●	●	●	●	●	●	●	●	●	●	●	●											
	Double 4" Traditional	●	●	●	●	●	●	●	●	●	●	●	●	●	●	●	●											
	Single 8" Traditional	●																										
<b>PAGE 10</b>	<b>NANTUCKET® 2.0</b>																											
	Double 4" Traditional	●	●	●	●	●	●	●	●	●	●	●	●	●	●	●	●											
	Double 4.5" Dutch Lap	●	●	●	●	●	●	●	●	●	●	●	●	●	●	●	●											
	Double 5" Traditional	●	●	●	●	●	●	●	●	●	●	●	●	●	●	●	●											
	Double 5" Dutch Lap	●	●	●	●	●	●	●	●	●	●	●	●	●	●	●	●											
<b>PAGE 11</b>	<b>BEADED PORCH PANEL</b>																											
	Triple 2-2/3" Beaded*	●					●																					
<b>PAGES 11-12</b>	<b>SOFFIT</b>																											
	Double 5" Select Solid Soffit*	●					●	●				●																
	Double 5" Select Full Vent Soffit*	●					●	●				●																
<b>NEW PROFILE</b>	Triple 4" Solid Soffit*	●					●	●				●				●												
<b>NEW PROFILE</b>	Triple 4" Full Vent Soffit*	●					●	●				●				●												
<b>NEW PROFILE</b>	Triple 4" Center Vent Soffit*	●																										
<b>NEW COLOR</b>	Triple 3-1/3" Solid Soffit	●																										★
<b>NEW COLOR</b>	Triple 3-1/3" Hidden Vent Soffit*	●																										★
<b>PAGES 13-16</b>	<b>ACCESSORIES &amp; STARTER STRIPS</b>																											

★ = NEW COLOR

†Dimensions shown are nominal

\*Soffit use only



# ACCESSORY MATRIX

	Corner Systems			J-Channel			Window & Door Trim		Functional Trim			Starter Strips
	3/4" Outside Corner Post	3/4" Inside Corner Post	Traditional 6" XL Corner	1/2" J-Channel	5/8" J-Channel	3/4" J-Channel	3.5" Lineal	Starter Strip	Utility Trim	F-Channel	H-Trim	Vinyl Starter Strip
<b>SIDING PRODUCTS</b>												
<b>SHINGLES</b>												
Single 7" Perfection	•	•	•			•	•	•	•			†
<b>PRESTIGE®</b>												
Double 4-1/2" Traditional	•	•	•		•		•	•	•			•
Double 4-1/2" Dutch Lap	•	•	•	•	•		•	•	•			•
Double 5" Dutch Lap	•	•	•		•		•	•	•			•
<b>BOARD &amp; BATTEN</b>												
Single 7" Vertical				•	•		•	•				•
<b>PROSIDE®</b>												
Double 4-1/2" Traditional	•	•	•	•	•		•	•	•			•
Double 4-1/2" Dutch Lap	•	•	•	•	•		•	•	•			•
Double 4" Traditional	•	•	•		•		•	•	•			•
Single 8" Traditional	•	•	•			•	•	•	•			•
<b>NANTUCKET® 2.0</b>												
Double 4" Traditional	•	•	•		•		•	•	•			•
Double 4" Dutch Lap	•	•	•	•	•		•	•	•			•
Double 5" Traditional	•	•	•		•		•	•	•			•
Double 5" Dutch Lap	•	•	•	•	•		•	•	•			•
<b>BEADED PORCH PANEL</b>												
Triple 2-2/3" Beaded*				•			•	•		•	•	
<b>SOFFIT</b>												
Double 5" Select Solid Soffit*				•	•		•	•		•	•	
Double 5" Select Full Vent Soffit*				•	•		•	•		•	•	
Triple 4" Solid Soffit*				•	•		•	•		•	•	
Triple 4" Full Vent Soffit*				•	•		•	•		•	•	
Triple 4" Center Vent Soffit*				•	•		•	•		•	•	
Triple 3-1/3" Solid Soffit					•	•	•	•		•	•	
Triple 3-1/3" Hidden Vent Soffit*					•	•	•	•		•	•	

†Dimensions shown are nominal

\*Soffit use only

# HEARTWOOD™ SHINGLES

## Single 7" Perfection Shingles

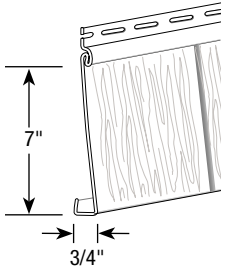

Finish: Perfection Cedar  
 Exposure: 7"  
 Panel Projection: 3/4"  
 Panel Length: 10' 1"

Packaging  
 Panels per ctn: 17  
 Sq. Feet per ctn: 100  
 Pounds per ctn: ≤ 65  
 Cartons per pallet: 18

### White

646766 White

### Colors

647102 Buttercream  
 647103 Maplewood  
 646768 Sierra Brown

### Premium

648341 Canyon Ridge  
 646774 Castle Stone  
 646770 Rustic Clay  
 646775 Tundra Moss  
 646773 Twilight Gray

### Expressions® Colors

646778 Harbour  
 646771 Rustic Oak  
 646779 Redwood  
 646772 Shoreline  
 646777 Smokestone  
 646903 Smoky Steel

# PRESTIGE®

## Double 4-1/2" Traditional

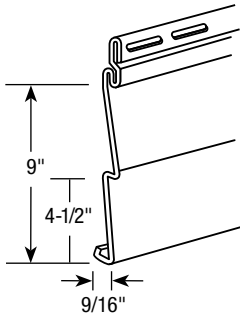

Finish: Cedar Grain  
 Thickness: 0.044"  
 Exposure: 9"  
 Panel Projection: 9/16"  
 Panel Length: 12' 11-1/8"

Packaging  
 Panels per ctn: 20  
 Sq. Feet per ctn: 194  
 Pounds per ctn: ≤ 91  
 Cartons per pallet: 14

**White**  
 636803

**Colors**  
 646850  
 646849  
 636802  
 646851  
 646876  
 637668

White  
 Buttercream  
 Classic Gray  
 Maplewood  
 Natural Sand  
 Sand Drift  
 Sierra Brown

**Premium**  
 637723  
 646847  
 637722  
 646846  
 637721  
 636801  
 637690  
 637691  
 637724

Canyon Ridge  
 Carolina Blue  
 Castle Stone  
 Grasslands  
 Lakeshore Blue  
 Rustic Clay  
 Spring Meadow  
 Tundra Moss  
 Twilight Gray

**Expressions® Colors**  
 637793  
 637790  
 650937  
 650938  
 637789  
 639157  
 637795  
 637794  
 650939  
 646848

Forest  
 Harbour  
 Marine Blue  
 Mocha Brown  
 Redwood  
 Rustic Oak  
 Shoreline  
 Smokestone  
 Smoky Quartz  
 Smoky Steel

## Double 4-1/2" Dutch Lap

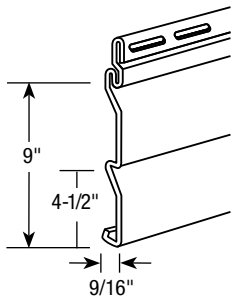

Finish: Cedar Grain  
 Thickness: 0.044"  
 Exposure: 9"  
 Panel Projection: 9/16"  
 Panel Length: 12' 11-1/8"

Packaging  
 Panels per ctn: 20  
 Sq. Feet per ctn: 194  
 Pounds per ctn: ≤ 91  
 Cartons per pallet: 16

**White**  
 644089

**Colors**  
 646853  
 646852  
 644096  
 646854  
 646877  
 644099

White  
 Buttercream  
 Classic Gray  
 Maplewood  
 Natural Sand  
 Sand Drift  
 Sierra Brown

**Premium**  
 644117  
 646856  
 644107  
 646855  
 644105  
 644090  
 644126  
 644108  
 644106

Canyon Ridge  
 Carolina Blue  
 Castle Stone  
 Grasslands  
 Lakeshore Blue  
 Rustic Clay  
 Spring Meadow  
 Tundra Moss  
 Twilight Gray

**Expressions® Colors**  
 644130  
 644129  
 650940  
 650941  
 644127  
 644086  
 644132  
 644131  
 650942  
 646857

Forest  
 Harbour  
 Marine Blue  
 Mocha Brown  
 Redwood  
 Rustic Oak  
 Shoreline  
 Smokestone  
 Smoky Quartz  
 Smoky Steel

## Double 5" Dutch Lap

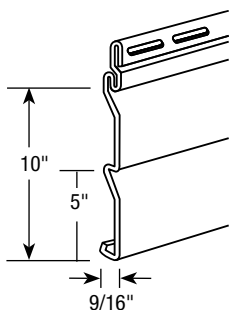

Finish: Cedar Grain  
 Thickness: 0.044"  
 Exposure: 10"  
 Panel Projection: 9/16"  
 Panel Length: 12' 11-1/2"

Packaging  
 Panels per ctn: 18  
 Sq. Feet per ctn: 194  
 Pounds per ctn: ≤ 83  
 Cartons per pallet: 17

**White**  
 644093

**Colors**  
 646859  
 646858  
 644098  
 646860  
 646878  
 644109

White  
 Buttercream  
 Classic Gray  
 Maplewood  
 Natural Sand  
 Sand Drift  
 Sierra Brown

**Premium**  
 644122  
 646862  
 644121  
 646861  
 644120  
 644097  
 644115  
 644116  
 644124

Canyon Ridge  
 Carolina Blue  
 Castle Stone  
 Grasslands  
 Lakeshore Blue  
 Rustic Clay  
 Spring Meadow  
 Tundra Moss  
 Twilight Gray

**Expressions® Colors**  
 644137  
 644136  
 650943  
 650944  
 644135  
 644088  
 644140  
 644139  
 650945  
 646863

Forest  
 Harbour  
 Marine Blue  
 Mocha Brown  
 Redwood  
 Rustic Oak  
 Shoreline  
 Smokestone  
 Smoky Quartz  
 Smoky Steel

# BOARD & BATTEN

## Single 7" Vertical

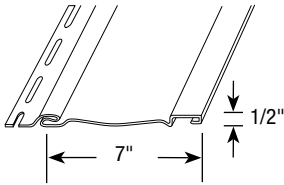

Finish: Cedar Grain  
 Thickness: 0.052"  
 Exposure: 7"  
 Panel Projection: 1/2"  
 Panel Length: 10'  
  
 Packaging  
 Panels per ctn: 17  
 Sq. Feet per ctn: 100  
 Pounds per ctn: ≤ 55  
 Cartons per pallet: 15

### White

646266

White

### Colors

647096

Buttercream

647101

Classic Gray

647097

Maplewood

647098

Natural Sand

647100

Sand Drift

646273

Sierra Brown

### Premium

648045

Canyon Ridge

646275

Castle Stone

647614

Lakeshore Blue

646274

Rustic Clay

647615

Spring Meadow

646276

Tundra Moss

646867

Twilight Gray

### Expressions® Colors

646269

Harbour

646270

Redwood

646267

Rustic Oak

646272

Shoreline

646271

Smokestone

646866

Smoky Steel



**Double 4-1/2" Traditional**

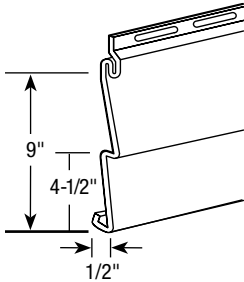

Finish: Woodgrain  
 Thickness: 0.042"  
 Exposure: 9"  
 Panel Projection: 1/2"  
 Panel Length: 12' 11-1/8"

Packaging  
 Panels per ctn: 20  
 Sq. Feet per ctn: 194  
 Pounds per ctn: ≤ 85  
 Cartons per pallet: 17

<b>White</b>		<b>Premium</b>	
637266	White	646841	Carolina Blue
		637269	Castle Stone
		646838	Grasslands
<b>Colors</b>		637273	Lakeshore Blue
646839	Buttercream	637275	Rustic Clay
646840	Classic Gray	637276	Spring Meadow
637279	Maplewood	637277	Tundra Moss
637311	Natural Sand	637278	Twilight Gray
646824	Sand Drift		
637274	Sierra Brown		

**Double 4-1/2" Dutch Lap**

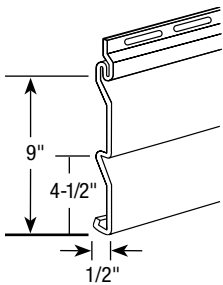

Finish: Woodgrain  
 Thickness: 0.042"  
 Exposure: 9"  
 Panel Projection: 1/2"  
 Panel Length: 12' 11-1/8"

Packaging  
 Panels per ctn: 20  
 Sq. Feet per ctn: 194  
 Pounds per ctn: ≤ 81  
 Cartons per pallet: 20

<b>White</b>		<b>Premium</b>	
637312	White	646843	Carolina Blue
		637282	Castle Stone
		646842	Grasslands
<b>Colors</b>		637286	Lakeshore Blue
646845	Buttercream	637288	Rustic Clay
646844	Classic Gray	637289	Spring Meadow
637292	Maplewood	637290	Tundra Moss
637294	Natural Sand	637291	Twilight Gray
646825	Sand Drift		
637287	Sierra Brown		

**Double 4" Traditional**

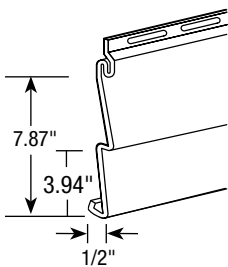

Finish: Woodgrain  
 Thickness: 0.042"  
 Exposure: 7.874"  
 Panel Projection: 1/2"  
 Panel Length: 12' 3-5/8"

Packaging  
 Panels per ctn: 24  
 Sq. Feet per ctn: 194  
 Pounds per ctn: ≤ 90  
 Cartons per pallet: 16

<b>White</b>		<b>Premium</b>	
637295	White	646829	Carolina Blue
		637298	Castle Stone
		646828	Grasslands
<b>Colors</b>		637302	Lakeshore Blue
646831	Buttercream	637304	Rustic Clay
646830	Classic Gray	637305	Spring Meadow
637308	Maplewood	637306	Tundra Moss
637310	Natural Sand	637307	Twilight Gray
646823	Sand Drift		
637303	Sierra Brown		

**Single 8" Traditional**

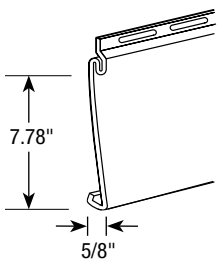

Finish: Woodgrain  
 Thickness: 0.045"  
 Exposure: 7.783"  
 Panel Projection: 5/8"  
 Panel Length: 12' 3-5/8"

Packaging  
 Panels per ctn: 24  
 Sq. Feet per ctn: 191  
 Pounds per ctn: ≤ 93  
 Cartons per pallet: 14

<b>White</b>	
636810	White

# NANTUCKET® 2.0

## Double 4" Traditional

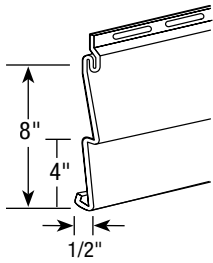

Finish: Woodgrain  
 Thickness: 0.040"  
 Exposure: 8"  
 Panel Projection: 1/2"  
 Panel Length: 12' 6"  
 Packaging  
 Panels per ctn: 24  
 Sq. Feet per ctn: 200  
 Pounds per ctn: ≤ 88  
 Cartons per pallet: 16

**White**  
 650634

White

**Colors**

650522 Buttercream  
 650575 Classic Gray  
 650627 Maplewood  
 650628 Natural Sand  
 650630 Sand Drift  
 650631 Sierra Brown

**Premium Colors**

650573 Carolina Blue  
 650574 Castle Stone  
 650626 Grasslands  
 650629 Rustic Clay  
 650632 Tundra Moss  
 650633 Twilight Gray

## Double 5" Traditional

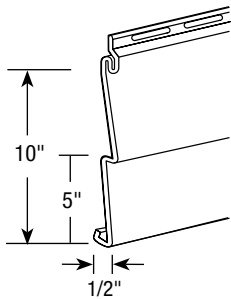

Finish: Woodgrain  
 Thickness: 0.040"  
 Exposure: 10"  
 Panel Projection: 1/2"  
 Panel Length: 12'  
 Packaging  
 Panels per ctn: 20  
 Sq. Feet per ctn: 200  
 Pounds per ctn: ≤ 87  
 Cartons per pallet: 17

**White**  
 650714

White

**Colors**

650622 Buttercream  
 650625 Classic Gray  
 650707 Maplewood  
 650708 Natural Sand  
 650710 Sand Drift  
 650711 Sierra Brown

**Premium Colors**

650623 Carolina Blue  
 650624 Castle Stone  
 650706 Grasslands  
 650709 Rustic Clay  
 650712 Tundra Moss  
 650713 Twilight Gray

## Double 4-1/2" Dutch Lap

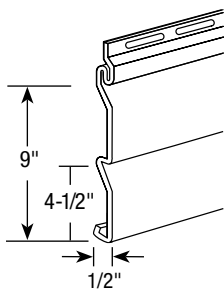

Finish: Woodgrain  
 Thickness: 0.040"  
 Exposure: 9"  
 Panel Projection: 1/2"  
 Panel Length: 12' 1"  
 Packaging  
 Panels per ctn: 22  
 Sq. Feet per ctn: 200  
 Pounds per ctn: ≤ 87  
 Cartons per pallet: 16

**White**  
 650696

White

**Colors**

650584 Buttercream  
 650687 Classic Gray  
 650689 Maplewood  
 650690 Natural Sand  
 650692 Sand Drift  
 650693 Sierra Brown

**Premium Colors**

650585 Carolina Blue  
 650686 Castle Stone  
 650688 Grasslands  
 650691 Rustic Clay  
 650694 Tundra Moss  
 650695 Twilight Gray

## Double 5" Dutch Lap

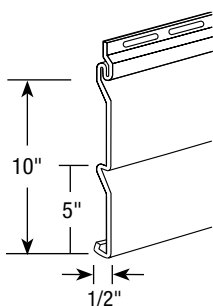

Finish: Woodgrain  
 Thickness: 0.040"  
 Exposure: 10"  
 Panel Projection: 1/2"  
 Panel Length: 12'  
 Packaging  
 Panels per ctn: 20  
 Sq. Feet per ctn: 200  
 Pounds per ctn: ≤ 87  
 Cartons per pallet: 14

**White**  
 650682

White

**Colors**

650613 Buttercream  
 650716 Classic Gray  
 650719 Maplewood  
 650720 Natural Sand  
 650722 Sand Drift  
 650723 Sierra Brown

**Premium Colors**

650614 Carolina Blue  
 650615 Castle Stone  
 650718 Grasslands  
 650721 Rustic Clay  
 650724 Tundra Moss  
 650681 Twilight Gray

## BEADED PORCH PANEL

### Triple 2-2/3" Porch Panel

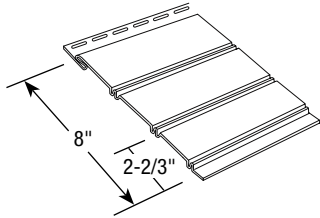

Finish: Brushed  
 Profile: Triple 2-2/3" Beaded  
 Thickness: 0.040"  
 Exposure: 8"  
 Panel Projection: 3/8"  
 Panel Length: 12'

**Packaging**  
 Panels per carton: 18  
 Sq. Feet per ctn: 144  
 Pounds per ctn: ≤ 78  
 Cartons per pallet: 22

**White**  
 636770 White

**Colors**  
 636922 Sierra Brown

## SOFFITS

### Double 5" Select Solid Soffit\*

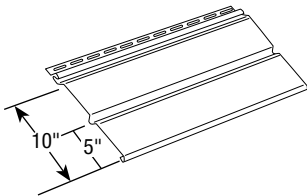

Finish: Brushed  
 Thickness: 0.040"  
 Exposure: 10"  
 Panel Projection: 1/2"  
 Panel Length: 12'

**Packaging**  
 Panels per ctn: 20  
 Sq. Feet per ctn: 200  
 Pounds per ctn: ≤ 88  
 Cartons per pallet: 14

**White**  
 637663 White

**Colors**  
 646880 Sand Drift  
 637766 Sierra Brown

**Premium Colors**  
 636917 Castle Stone  
 636914 Rustic Clay

### Double 5" Select Full Vent Soffit\*

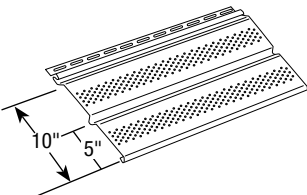

Finish: Brushed  
 Thickness: 0.040"  
 Exposure: 10"  
 Panel Projection: 1/2"  
 Panel Length: 12'

**Packaging**  
 Panels per ctn: 20  
 Sq. Feet per ctn: 200  
 Pounds per ctn: ≤ 88

Ventilation: Perforated  
 Vent Area: 4.0 sq. in. / ft.  
 Cartons per pallet: 14

**White**  
 637664 White

**Colors**  
 646881 Sand Drift  
 637756 Sierra Brown

**Premium Colors**  
 636910 Castle Stone  
 636907 Rustic Clay

\*Soffit use only

# SOFFITS (continued)

## Triple 4" Solid Soffit\*

**NEW PROFILE**

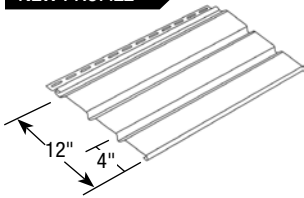

Finish: Matte  
 Thickness: 0.036"  
 Exposure: 12"  
 Panel Projection: 7/16"  
 Panel Length: 12'

Packaging  
 Panels per ctn: 16  
 Sq. Feet per ctn: 192  
 Pounds per ctn: ≤ 74  
 Cartons per pallet: 18

**White**  
 652179

White

**Premium Colors**  
 652181 Rustic Clay  
 652182 Twilight Gray

**Colors**  
 652183  
 652180

Sand Drift  
 Sierra Brown

## Triple 4" Full Vent Soffit\*

**NEW PROFILE**

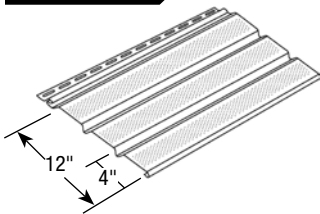

Finish: Matte  
 Thickness: 0.036"  
 Exposure: 12"  
 Panel Projection: 7/16"  
 Panel Length: 12'

Packaging  
 Panels per ctn: 16  
 Sq. Feet per ctn: 192  
 Pounds per ctn: ≤ 72  
 Cartons per pallet: 18

Ventilation: Perforated  
 Vent Area: 5.9 sq. in. / ft.

**White**  
 652227

White

**Premium Colors**  
 652217 Rustic Clay  
 652219 Twilight Gray

**Colors**  
 652220  
 652218

Sand Drift  
 Sierra Brown

## Triple 4" Center Vent Soffit\*

**NEW PROFILE**

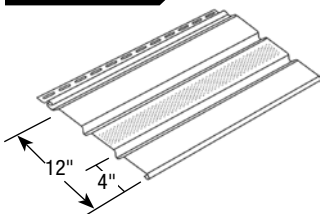

Finish: Matte  
 Thickness: 0.036"  
 Exposure: 12"  
 Panel Projection: 7/16"  
 Panel Length: 12'

Packaging  
 Panels per ctn: 16  
 Sq. Feet per ctn: 192  
 Pounds per ctn: ≤ 73  
 Cartons per pallet: 15

Ventilation: Perforated  
 Vent Area: 2.0 sq. in. / ft.

**White**  
 652178

White

## Triple 3-1/3" Solid Soffit

**NEW COLOR**

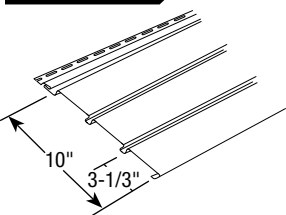

Finish: Matte  
 Thickness: 0.040"  
 Exposure: 10"  
 Panel Projection: 5/8"  
 Panel Length: 12'

Packaging  
 Panels per ctn: 20  
 Sq. Feet per ctn: 200  
 Pounds per ctn: ≤ 103  
 Cartons per pallet: 14

**White**  
 648473

White

**Dark**  
 652216

Black\* **NEW**

## Triple 3-1/3" Hidden Vent Soffit

**NEW COLOR**

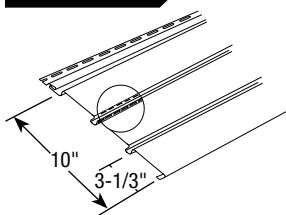

Finish: Matte  
 Thickness: 0.040"  
 Exposure: 10"  
 Panel Projection: 5/8"  
 Panel Length: 12'

Packaging  
 Panels per ctn: 20  
 Sq. Feet per ctn: 200  
 Pounds per ctn: ≤ 94  
 Cartons per pallet: 14

Vent Area: 9.65" sq. in. / ft.

**White**  
 648474

White

**Dark**  
 652246

Black\* **NEW**

\*Soffit use only

# ACCESSORIES - CORNER SYSTEMS

## 3/4" Outside Corner Post

Finish: Brushed  
 Exposure: 3-1/3"  
 Pocket: 3/4"  
 Length: 10'

Packaging  
 Pieces per ctn: 10  
 Feet per ctn: 100'  
 Pounds per ctn: ≤ 39  
 Cartons per pallet: 17

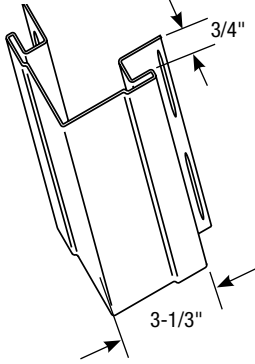

### White

White

### Colors

646905 Buttercream  
 646926 Classic Gray  
 637314 Maplewood  
 637315 Natural Sand  
 646927 Sand Drift  
 634950 Sierra Brown

### Premium

634959 Canyon Ridge  
 646928 Carolina Blue  
 634958 Castle Stone  
 639178 Grasslands  
 634957 Lakeshore Blue  
 637316 Rustic Clay  
 634963 Spring Meadow  
 634956 Tundra Moss  
 634960 Twilight Gray

### Expressions® Colors

634964 Forest  
 634966 Harbour  
 650932 Marine Blue  
 650930 Mocha Brown  
 634965 Redwood  
 639177 Rustic Oak  
 634968 Shoreline  
 634967 Smokestone  
 650929 Smoky Quartz  
 646929 Smoky Steel

## 3/4" Inside Corner Post

Finish: Matte  
 Exposed face: 1-1/2"  
 Pocket: 3/4"  
 Length: 10'

Packaging  
 Pieces per ctn: 10  
 Feet per ctn: 100'  
 Pounds per ctn: ≤ 20  
 Cartons per pallet: 24

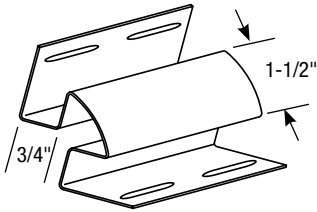

### White

634979

White

### Colors

646930 Buttercream  
 646931 Classic Gray  
 636893 Maplewood  
 636892 Natural Sand  
 646932 Sand Drift  
 634971 Sierra Brown

### Premium

634985 Canyon Ridge  
 646933 Carolina Blue  
 634984 Castle Stone  
 639165 Grasslands  
 634983 Lakeshore Blue  
 636891 Rustic Clay  
 634988 Spring Meadow  
 634982 Tundra Moss  
 634986 Twilight Gray

### Expressions® Colors

634989 Forest  
 634991 Harbour  
 650935 Marine Blue  
 650934 Mocha Brown  
 634990 Redwood  
 639179 Rustic Oak  
 634993 Shoreline  
 634992 Smokestone  
 650933 Smoky Quartz  
 646934 Smoky Steel

## Traditional 6" XL Corner With Foam Insert

Finish: Matte  
 Exposure: 6"  
 Pocket: 3/4"  
 Length: 20'

Packaging  
 Pieces per ctn: 6  
 Feet per ctn: 120'  
 Pounds per ctn: ≤ 77  
 Cartons per pallet: 9

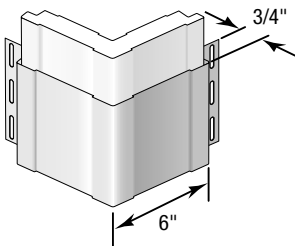

### White

638372

White

# ACCESSORIES - J-CHANNEL

## 5/8" J-Channel

**NEW COLOR**

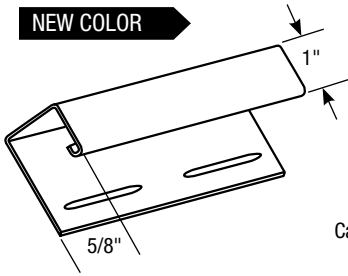

Finish: Matte  
 Exposure: 1"  
 Pocket: 5/8"  
 Length per piece: 12' 6"  
 Packaging  
 Pieces per ctn: 40  
 Feet per ctn: 500'  
 Pounds per ctn: ≤ 44  
 Cartons per pallet: 35

**White**  
 636863

White

**Colors**

646943 Buttercream  
 646944 Classic Gray  
 636811 Maplewood  
 636854 Natural Sand  
 646945 Sand Drift  
 636858 Sierra Brown

**Premium**

636844 Canyon Ridge  
 646946 Carolina Blue  
 636845 Castle Stone  
 639187 Grasslands  
 636853 Lakeshore Blue  
 636856 Rustic Clay  
 636860 Spring Meadow  
 636861 Tundra Moss  
 636862 Twilight Gray

**Dark**

656597

Black\* **NEW**

**Expressions® Colors**

636848 Forest  
 636849 Harbour  
 650981 Marine Blue  
 650980 Mocha Brown  
 636855 Redwood  
 639186 Rustic Oak  
 636857 Shoreline  
 636859 Smokestone  
 650979 Smoky Quartz  
 646947 Smoky Steel

\*Soffit use only

## 3/4" J-Channel

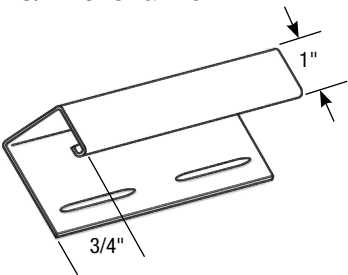

Finish: Matte  
 Exposure: 1"  
 Pocket: 3/4"  
 Length per piece: 12' 6"  
 Packaging  
 Pieces per ctn: 40  
 Feet per ctn: 500'  
 Pounds per ctn: ≤ 56  
 Cartons per pallet: 30

**White**

636885

White

**Colors**

648510 Buttercream  
 648511 Maplewood  
 636880 Sierra Brown

**Premium**

636867 Canyon Ridge  
 636868 Castle Stone  
 636878 Rustic Clay  
 636882 Spring Meadow  
 636884 Twilight Gray  
 636883 Tundra Moss

**Expressions® Colors**

636875 Forest  
 636873 Harbour  
 636877 Redwood  
 639188 Rustic Oak  
 636879 Shoreline  
 636881 Smokestone  
 646948 Smoky Steel

## 1/2" J-Channel

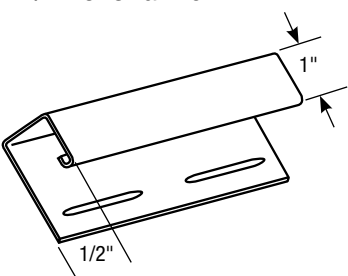

Finish: Matte  
 Exposure: 1"  
 Pocket: 1/2"  
 Length per piece: 12' 6"  
 Packaging  
 Pieces per ctn: 40  
 Feet per ctn: 500'  
 Pounds per ctn: ≤ 45  
 Cartons per pallet: 35

**White**

636840

White

**Colors**

646949 Buttercream  
 646950 Classic Gray  
 636851 Maplewood  
 636830 Natural Sand  
 646951 Sand Drift  
 636835 Sierra Brown

**Premium**

636820 Canyon Ridge  
 646952 Carolina Blue  
 636821 Castle Stone  
 639190 Grasslands  
 636828 Lakeshore Blue  
 636832 Rustic Clay  
 636837 Spring Meadow  
 636838 Tundra Moss  
 636839 Twilight Gray

**Expressions® Colors**

636824 Forest  
 636825 Harbour  
 636831 Redwood  
 639189 Rustic Oak  
 636834 Shoreline  
 636836 Smokestone  
 646953 Smoky Steel



## ACCESSORIES - WINDOW & DOOR TRIM

### 3-1/2" Lineal\*

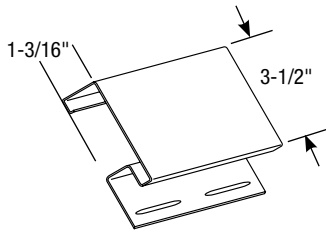

Finish: Matte  
 Exposure: 3-1/2"  
 Pocket: 3/4"  
 Length per piece: 20'

Packaging  
 Pieces per ctn: 10  
 Feet per ctn: 200'  
 Pounds per ctn: ≤ 50  
 Cartons per pallet: 30

\*To be used with window & door starter strip

**White**  
 648556 White

## ACCESSORIES - FUNCTIONAL TRIM

### Utility Trim

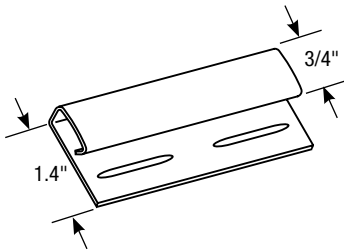

Finish: Matte  
 Exposure: 3/4"  
 Length per piece: 12' 6"

Packaging  
 Pieces per ctn: 40  
 Feet per ctn: 500'  
 Pounds per ctn: ≤ 49  
 Cartons per pallet: 38

**White**  
 637265 White

**Premium (continued)**  
 637257 Rustic Clay  
 637262 Spring Meadow  
 637263 Tundra Moss  
 637264 Twilight Gray

**Colors**  
 646936 Buttercream  
 646937 Classic Gray  
 637254 Maplewood  
 637255 Natural Sand  
 646938 Sand Drift  
 637259 Sierra Brown

**Expressions® Colors**  
 637249 Forest  
 637250 Harbour  
 650978 Marine Blue  
 650977 Mocha Brown  
 637256 Redwood  
 639191 Rustic Oak  
 637260 Shoreline  
 637261 Smokestone  
 650976 Smoky Quartz  
 646940 Smoky Steel

**Premium**  
 637247 Canyon Ridge  
 646939 Carolina Blue  
 637245 Castle Stone  
 639192 Grasslands  
 637253 Lakeshore Blue

### F-Channel

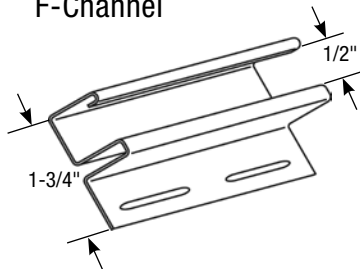

Finish: Matte  
 Length per piece: 12' 6"  
 Pocket: 1/2"

Packaging  
 Pieces per ctn: 24  
 Feet per ctn: 300'  
 Pounds per ctn: ≤ 35  
 Cartons per pallet: 38

**White**  
 636887 White

### H-Trim

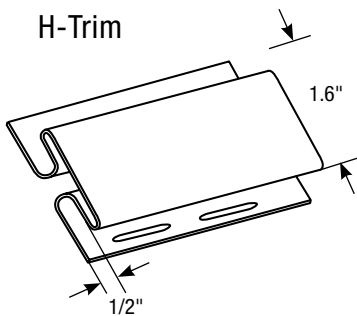

Finish: Matte  
 Length per piece: 12' 6"  
 Pocket: 1/2"

Packaging  
 Pieces per ctn: 10  
 Feet per ctn: 125'  
 Pounds per ctn: ≤ 25  
 Cartons per pallet: 28

**White**  
 636812 White

## STARTER STRIPS

### Vinyl Starter Strip

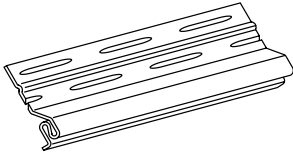

Length per piece: 12'

Packaging

Pieces per ctn: 50

Feet per ctn: 600'

Pounds per ctn: 67

Cartons per pallet: 20

**White**

633946

White

### Window & Door Starter Strip

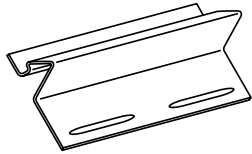

Length per piece: 10'

Packaging

Pieces per ctn: 36

Feet per ctn: 360'

Pounds per ctn:  $\leq$  35

Cartons per pallet: 27

**White**

648475

No Color